



# Woltex M

Woltex M is a horizontal Woltmann meter available as MID approved in sizes from DN 50 to 300mm. Recognized for its robustness the woltex M range is dedicated to all applications around water distribution where high reliability and accuracy is requested.

## FEATURES AND BENEFITS

- » Sensitivity class U0D0
- » Hermetically sealed register (copper can/mineral glass envelope)
- » Approved interchangeable mechanisms allow maintenance of on-site existing bodies, with preserved CE marking on the whole instrument according to the provisions of 2014/32/EU Directive.
- » Pre-equipped through Cyble as a standard
- » Excellent resistance to corrosion with 300 microns epoxy coating

## Reliability of the Measurement

Woltex is ensuring accurate and reliable data collection in a large scope of flow-rates typical of water network applications.

## Insensitivity to flow perturbation

The design of Woltex M range has been improved to achieve the sensitivity class U0D0, thanks to a new integrated stabilizer.

## Endurance & Peak Flow Resistance

This extended range of measurement is the result of more than twenty years experience in Horizontal Woltmann design, from the first hydrodynamically balanced helix patent in 1985 still resulting in unmatched endurance capabilities to the use of high quality materials.

## Ease of Installation, Read and Maintenance

Woltex M range is available in various lengths and connections to minimize installation costs. Interchangeable approved mechanisms allows easy maintenance without re-calibration. Ease of read in the toughest environments (ie: flooded pits) is secured by orientable hermetically sealed register (copper can/mineral glass envelope).

## Communication Device

Pre-equipped for future communication through Cyble.

## WORKING PRINCIPLE

The water velocity is rotating the horizontal axis propeller. Special shape of its inlet and outlet bearing **1** is counteracting the natural hydraulic thrust applied on the propeller then preventing any downstream pivot wear.

The hydrodynamic balance proved its ability for more than 30 years. This results in a meter able to withstand sustained high flows without impacting low flow accuracy.

The propeller rotation is transmitted by a protected transmission and direct magnetic coupling **2** to the register. The cast iron body **3** is durably protected against the effects of corrosion by epoxy powder coating. The hermetically sealed copper can/mineral glass register **4** is safeguarding the read and integrity of the indicator in the toughest environments (flooded pits, mechanical tampering attempts, ...). New stabilizer design **5** for DN 50/65/80 mm.

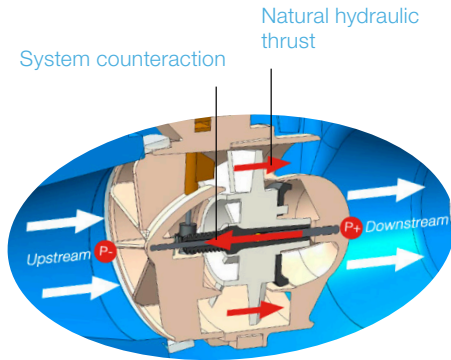

Hydrodynamic balance of helix

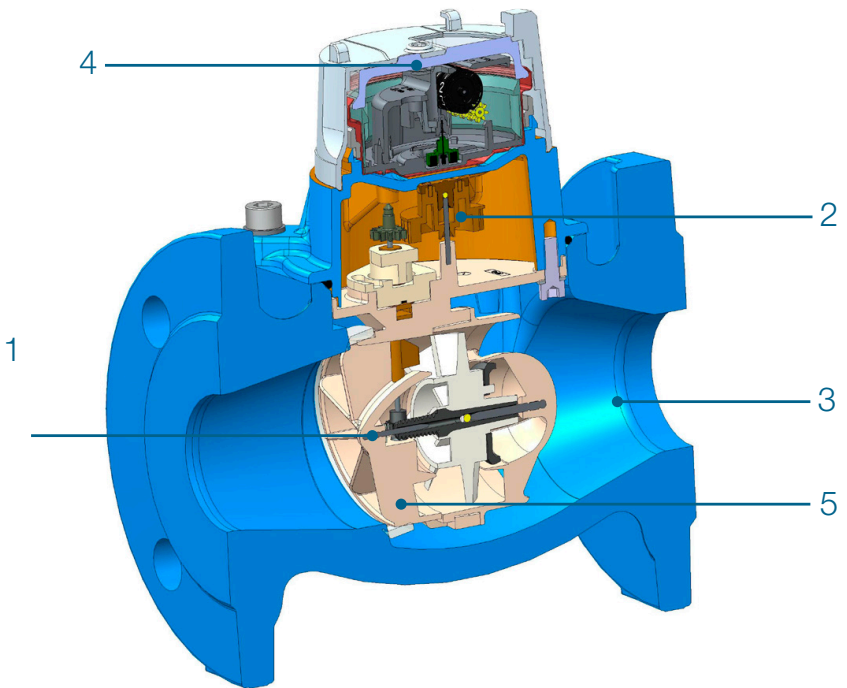

Woltex M totalizer from DN 50 to DN80



Woltex M totalizer from DN100 to DN300

## COMMUNICATION

### Woltex M is supplied pre-equipped with Cyble Target

Allows communication and remote reading through:

- » Walk-by & Drive-By Systems
- » Pulse output (Cyble Sensor)
- » Radio frequency LoRaWAN & Sigfox networks (Cyble 5)

These Cyble modules allow the Woltex M meter to be connected with various associated systems like our supervision system WaterMind (see specific leaflet).

They are particularly adapted to commercial and industrial applications where a need for frequent meter monitoring is expressed especially in hard-to-read locations.

### Key Advantages of Cyble Technology

- » No need for additional investment on the meter to implement remote reading
- » Itron standardized meter interface, irrespective of meter technology and widely spread on Itron water meters range
- » Reliable electronic switching (no wear or bouncing)
- » Reverse flow management
- » Field proven technology with a 25 years experience
- » Not affected by magnetic tampering

## METROLOGICAL CHARACTERISTICS

### Typical Performance

Nominal diameter (DN)	mm	50	65	80	100/125	150	200	250	300	
	inches	2"	2" ½	3"	4"	6"	8"	10	12	
Starting flowrate*	m³/h	0.19	0.22	0.25	0.38	0.4	1.6	3	10	
Accuracy ± 2% from*	m³/h	0.4	1	1.2	1.5	1.6	3.5	5	15	
Accuracy ± 5% from*	m³/h	0.35	0.5	0.75	0.9	1	2.5	3.5	12	
Admissible peak flow (10' max)	m³/h	90	160	250	300	700	1000	1500	2500	
Max. admissible flowrate (continuous)	m³/h	50	79	125	200	500	788	1250	2000	
Head loss at Q3	bar	0.09	0.27	0.31	0.15	0.14	0.12	0.12	0.2	
Max. admissible temperature	°C	30								
Climatic environment temperature	°C	70								
Max. admissible pressure	bar	20								
Min. Verification scale interval	L	0.2	0.2	0.2	0.2	2	2	2	2	
Indicating range m³	m³	999 999.99				9 999 999.9				
Sensitivity Class		UODO				UODO				
Cyble HF pulse weight	L	10	10	10	10	100	100	100	100	

\* Average values.

### MID Approval Values

Nominal diameter (DN)	mm	50	65	80	100/125	150	200	250	300
	inches	2"	2" ½	3"	4"	6"	8"	10	12
Q3 Permanent flow rate	m³/h	40	63	100	160	400	400	1000	1600
Q4 Overload flow rate	m³/h	50	79	125	200	500	787,5	1250	2000
Q2 Transitional flowrate	m³/h	0.64	1	1.60	1.60	4.00	25.20	40.00	32.00
Q1 Minimum flowrate	m³/h	0.4	0.63	1.00	1.00	2.50	15.75	25.00	20.00
MID approval ratio		100	100	100	160	160	40	40	80
Production ratio		100	100	100	100	100	40	40	80
Maximum admissible Pressure (MAP)	bar	20							
Pressure Loss Class at Q3	bar	0.16	0.4	0.4	0.4	0.16	0.25	0.25	0.25
Mid Approval number		LNE-23696							
Max. temperature	°C	30							

### HEAD LOSS

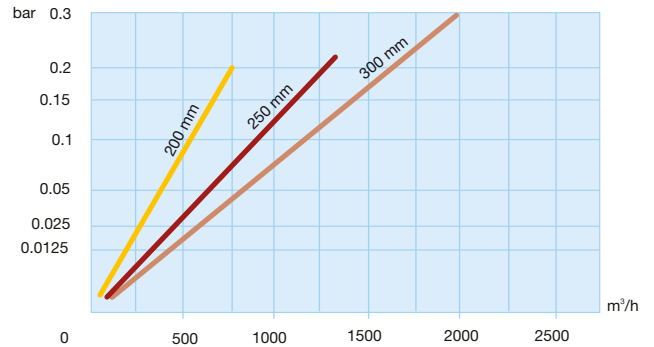
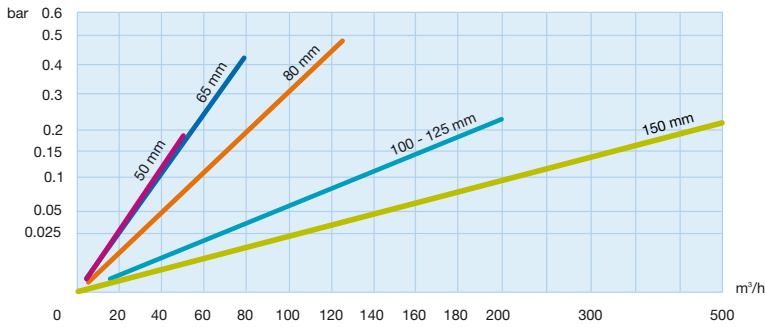

### ACCURACY CURVE

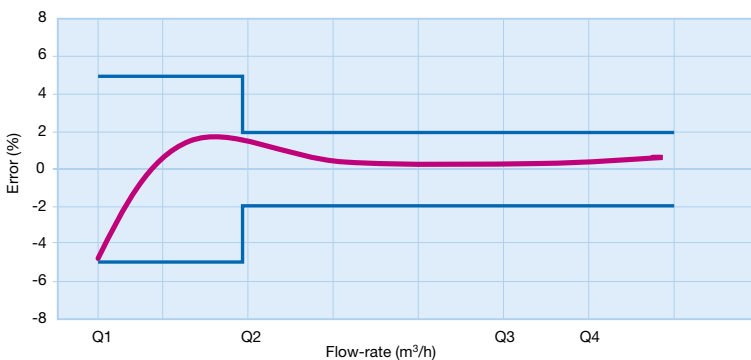

Cyble RF fitted on Woltex M Inlet stabilizer for DN100 and DN150.

## Dimensions

Nominal diameter (DN)		50	65	80	100	125	150	200	250	300	
	mm inches	2"	2" 1/2	3"	4"	5"	6"	8	10	12	
End connection*		Flange PN 10/16						Flange PN 10 or PN 16			
<b>&gt; Meter</b>											
A (length)	ISO	mm	200	200	200	250	250	300	350	450	500
	DIN	mm	200	200	225	250	-	300			
	AS (Australia/UK)	mm	311	-	413	-	-	-			
B		mm	100	100	100	111	111	139	164	214	200
C		mm	100	100	100	139	139	161	186	236	300
D		mm	82.5	92.5	100	110	110	142.5	171	204	230
E		mm	142	142	142	169	169	194	220	195	342
F		mm	224	234	242	279	279	339	391	399	564
H		mm	222	222	222	309	309	395	420	395	729
Weight		Kg	11.4	12.6	14.1	19.5	19.5	34	55	75	175
<b>&gt; Mechanism</b>											
L		mm	119	119	119	166	166	212	332	256	350
I (max. width)		mm	148	148	148	182	182	273	276	276	426
M		mm	142	142	142	169	241	194	195	195	342
Weight		Kg	3	3	3	5.4	5.4	7.8	8,5	8,5	54

\* Other drillings are available, under request

## INSTALLATION REQUIREMENTS

- » Woltex M could be installed regardless of position.
- » Installation of a strainer upstream of the meter is recommended to protect the hydraulics against raw particles (see Itron strainer leaflet).
- » In case of particular installation conditions, we recommend the installation of a flow straightener directly upstream of the meter to cancel the effects of hydraulic perturbations on Horizontal Woltmann accuracy (see Itron installation leaflet).

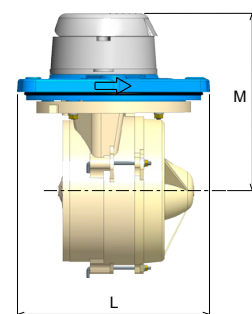
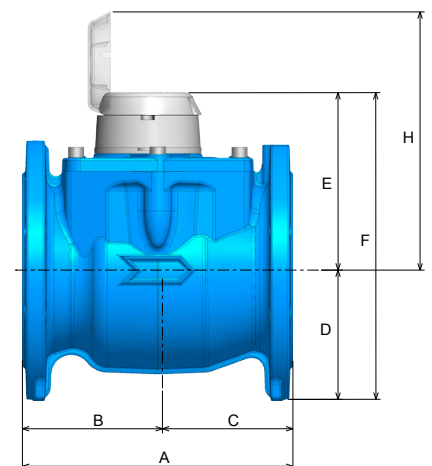

Join us in creating a more **resourceful world**.  
To learn more visit **itron.com**

While Itron strives to make the content of its marketing materials as timely and accurate as possible, Itron makes no claims, promises, or guarantees about the accuracy, completeness, or adequacy of, and expressly disclaims liability for errors and omissions in, such materials. No warranty of any kind, implied, expressed, or statutory, including but not limited to the warranties of non-infringement of third party rights, title, merchantability, and fitness for a particular purpose, is given with respect to the content of these marketing materials. © Copyright 2021 Itron. All rights reserved. **WA-0062.10-EN-06.21**

### GANZ METER COMPANY LTD

Tancsics Mihály út 11.  
P.O.B. 396  
H-2101 Gödöllő  
Hungary

**Phone:** +36 28 520 600  
**Fax:** +36 28 520 605